

PRODUCT INFORMATION

All information is subject to change without notice. Please read bottom notes.**FEATURES**

- (1) 5.61WIDE-SVGA(1024x600 pixels) display size for mini-notebook PC
- (2) LVDS interface system (H-Sync, V-Sync)
- (3) High Resolution 211ppi
- (4) Glare surface (with AR coating)

TENTATIVE**MECHANICAL SPECIFICATIONS**

Item	Specifications
Dimensional Outline (typ.)	141.8(W) x 84.4 (H) x 7.5max(D) mm
Number of Pixels	1024(W) x 600(H) pixels
Active Area	122.88 (W) x 72(H) mm
Pixel Pitch	0.120(W) x 0.120(H)
Weight (approximately)	75 g(typ)
Backlight	Single CCFL, Sidelight type

ABSOLUTE MAXIMUM RATINGS

Item	Symbol	Min.	Max.	Unit	Checked Terminal
Supply Voltage	(V_{DD})	-0.3	+4.0	V	$V_{DD} - GND$
Input Voltage of Signals	(V_{IN})	-0.3	$V_{DD}+0.3$	V	LVDS interface
Operating Ambient Temperature	(T_{OP})	0	50	°C	
Operating Ambient Humidity	(H_{OP})	10	90	%(RH)	
Storage Temperature	(T_{STG})	-20	+60	°C	
Storage Humidity	(H_{STG})	10	90	%(RH)	

ELECTRICAL SPECIFICATION

Item	Symbol	Min.	Typ.	Max.	Unit	Remarks
Supply Voltage ¹⁾	(V_{DD})	3.0	3.3	3.6	V	
	(V_{FL})	---	500	---	V(rms)	$I_{FL}=4.0$ mA(rms)
FL Start Voltage ($T_a=0^\circ\text{C}$)	(V_{SFL})	1000	---	1500	V(rms)	
Common Mode Input Voltage ²⁾	(V_{CM})	0.5	1.2	1.75	V	
Differential Input High Threshold	(V_{TH})	-	-	100	mV	$V_{CM}=1.2\text{V}$
Differential Input Low Threshold	(V_{TL})	-100	-	-	mV	$V_{CM}=1.2\text{V}$
Current Consumption	(I_{DD}) ¹⁾	---	200	---	mA	
	(I_{FL}) ²⁾	---	4.0	5.0	mA(rms)	
Power Consumption		---	2.66	---	W	$I_{FL}=4.0$ mA(rms)

*1) The module should be always operated within these ranges. The "Typ." shows the recommendable value.

*2) Recommended LVDS transmitter: DS90CF365

OPTICAL SPECIFICATION ($T_a=25^\circ\text{C}$)

Item	Min.	Typ.	Max.	Unit	Remarks
Contrast Ratio (CR)	100	200	---	---	
Response Time	(t_{ON})	---	7	---	ms
	(t_{OFF})	---	18	---	ms
Luminance (L)	110	165	---	cd/m ²	$I_{FL}=5.0$ mA(rms)

*The information contained herein is presented only as a guide for the applications of our products. No responsibility is assumed by Toshiba Matsushita Display Technology or other rights of the third parties which may result from its use. No license is granted by implication or otherwise under any patent or patent rights of Toshiba or others.

*The information contained herein may be changed without prior notice. It is therefore advisable to contact Toshiba before proceeding with the design of equipment incorporating this product.

Unit : mm

Standard tolerance : ±0.5

DIMENSIONAL OUTLINE

(Front side)

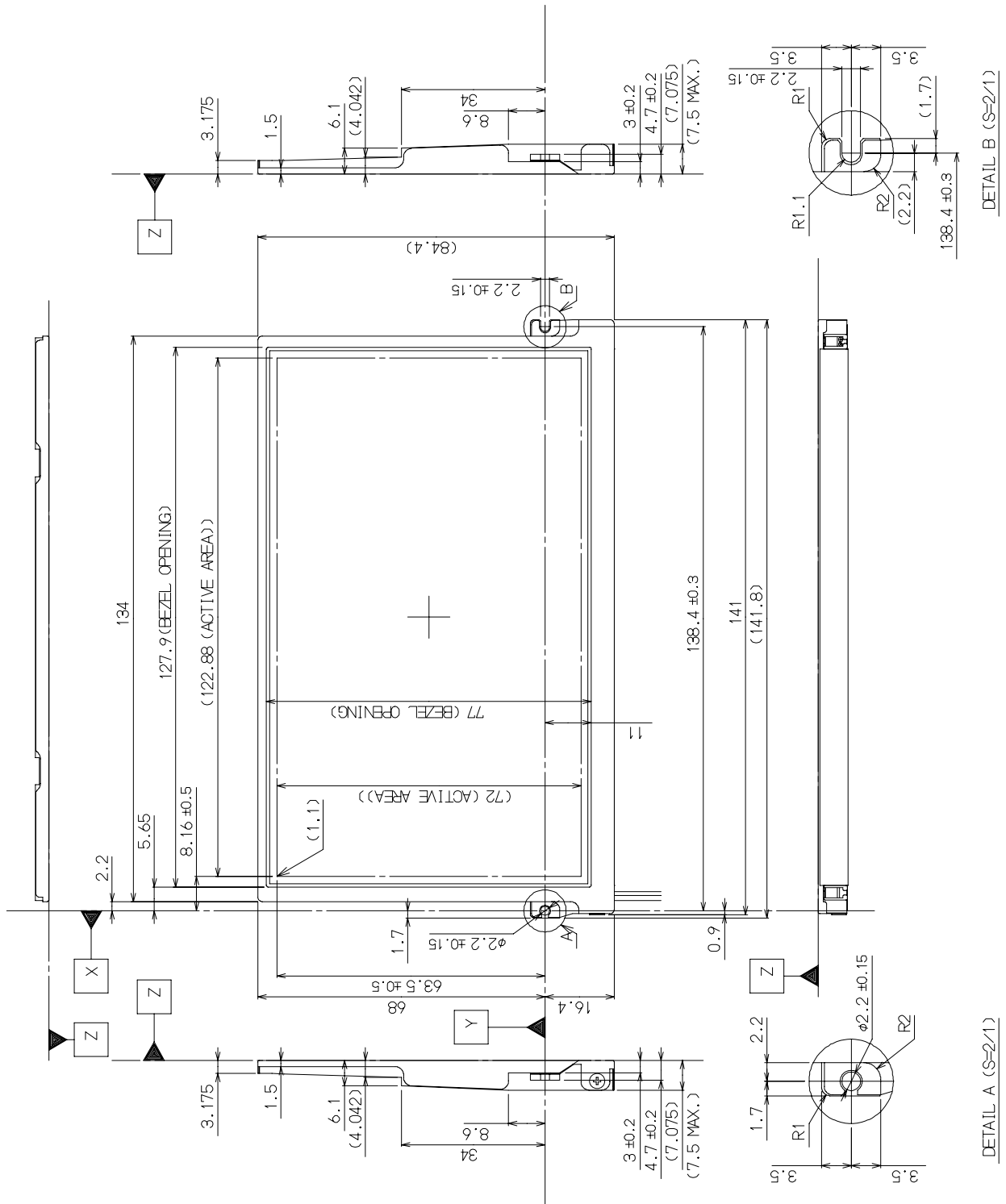

Note) If customer remove tape for fixing FL cable, Toshiba Matsushita Display Technology can not guarantee.

DIMENSIONAL OUTLINE
(Back side)

TENTATIVE

Unit : mm
Standard tolerance : ±0.5

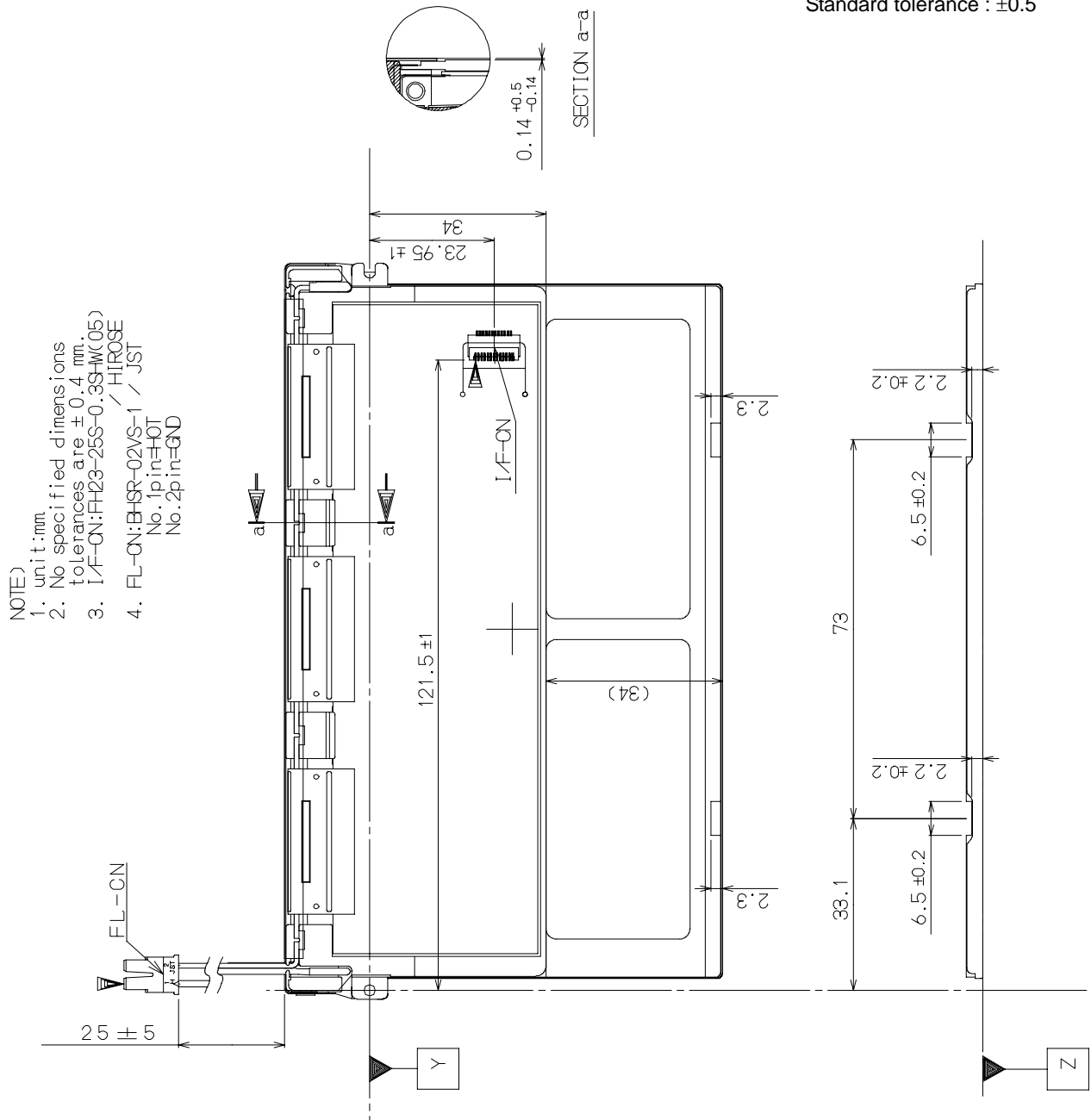

- NOTE)
1. unit:mm
 2. No. specified dimensions tolerances are ± 0.4 mm.
 3. I/F-CN: FH23-25S-0.3S-H(C05) / HIROSE
 4. FL-CN: BHSR-02VS-1 / JST
No. 1pin=HOT
No. 2pin=GND

Note 1) Never push LCD back side. If LCD back side was pressed, It may cause damage of the back light system.

BLOCK DIAGRAM

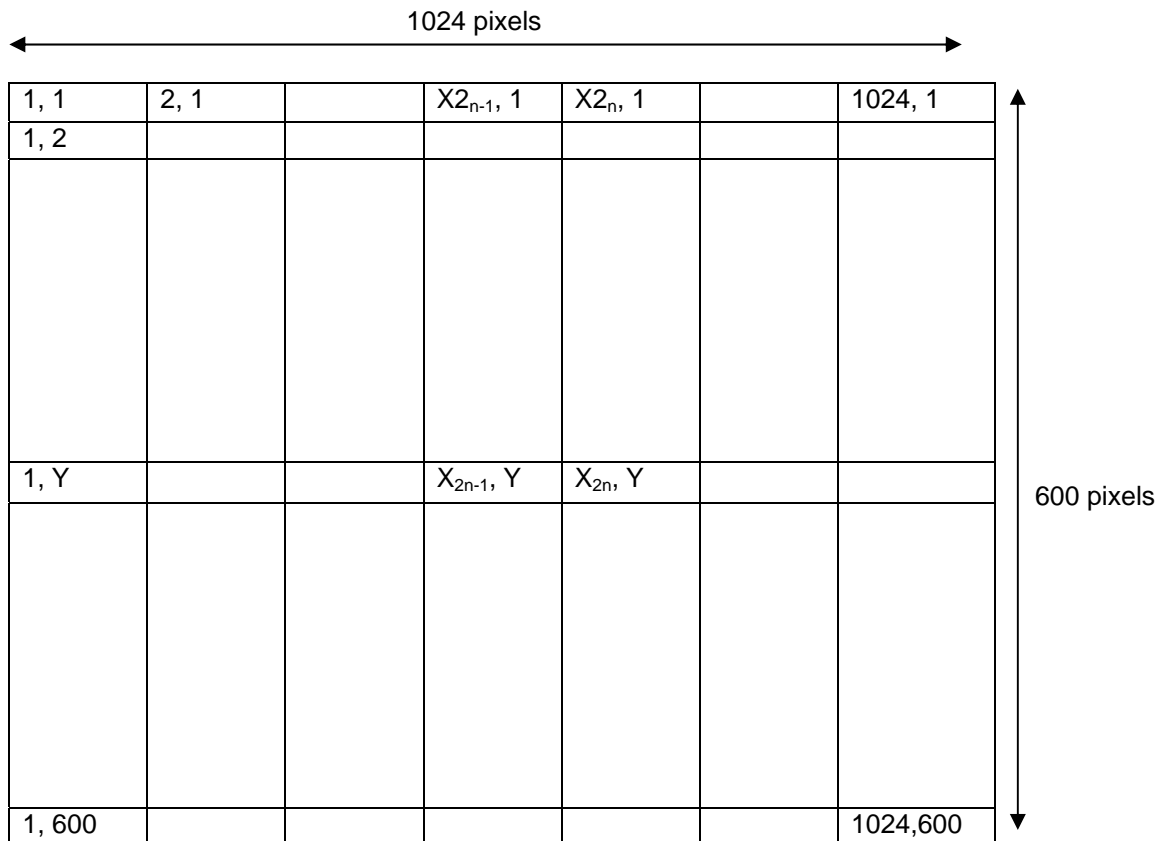
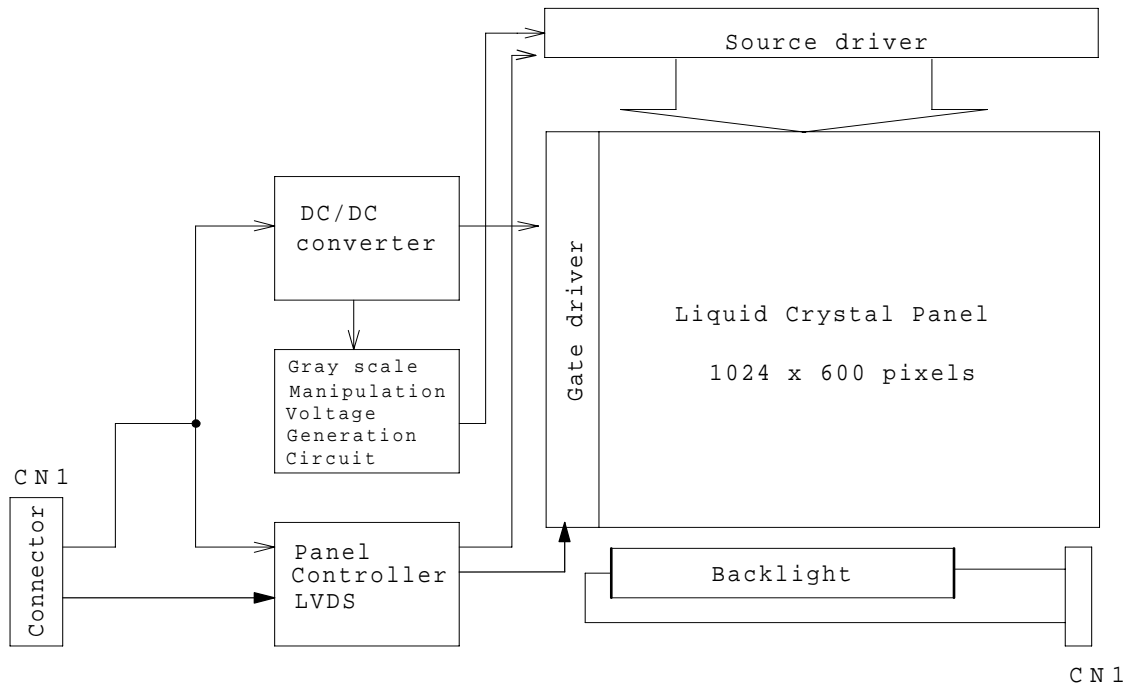

TIMING CHART

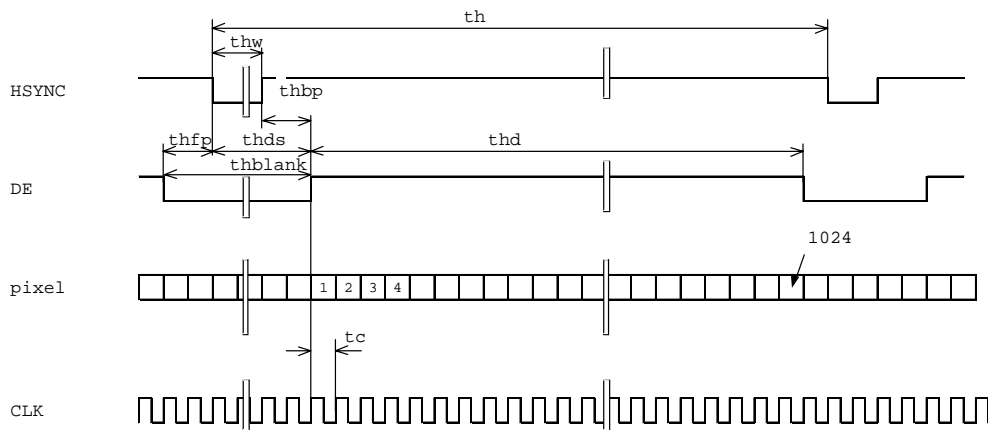
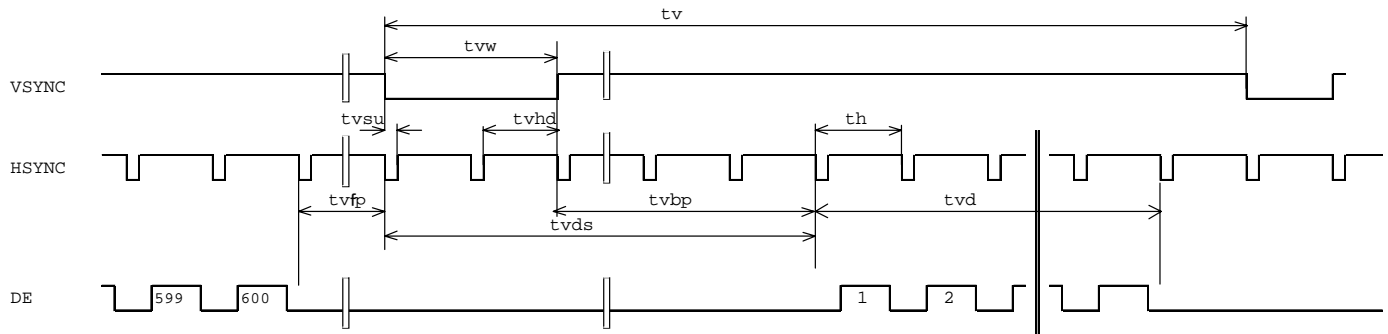

TIMING SPECIFICATION ^{1) 2) 3) 4) 5) 6)}

Item	Symbol	min.	typ.	max.	unit
Horizontal Scanning Term	t_h	$1334 \times t_c$	$1344 \times t_c$	-	clock
H-sync Pulse Width	t_{hw}	$8 \times t_c$	$136 \times t_c$	-	clock
Horizontal Front Porch	t_{hfp}	$4 \times t_c$	$24 \times t_c$	-	clock
Horizontal Back Porch	t_{hbp}	$24 \times t_c$	$160 \times t_c$	-	clock
Horizontal Data Sync Period	t_{hds}	$32 \times t_c$	$296 \times t_c$	-	clock
Horizontal Display Term	t_{hd}	$1024 \times t_c$	$1024 \times t_c$	$1024 \times t_c$	clock
Frame Period	t_v	$778 \times t_h$	$806 \times t_h$	$860 \times t_h$	line
V-sync Pulse Width	t_{vw}	$2 \times t_h$	$6 \times t_h$	-	line
V-sync Set Up Time (to H-sync)	t_{vsu}	$8 \times t_c$	-	-	clock
V-sync Hold Time	t_{vhd}	$8 \times t_c$	-	-	clock
Vertical Front Porch	t_{vfp}	$1 \times t_h$	$3 \times t_h$	-	line
Vertical Back Porch	t_{vbp}	$2 \times t_h$	$29 \times t_h$	-	line
Vertical Data Sync Period	t_{vds}	$8 \times t_h$	$35 \times t_h$	-	line
Vertical Display Term	t_{vd}	$600 \times t_h$	$600 \times t_h$	$600 \times t_h$	line
Clock Period	t_c	15.0	15.38	-	ns

Note 1) Refer to "Timing Chart" and LVDS (DS90CF364, DS90CF384) specifications by National semiconductor corporation.

Note 2) If DE is fixed to "H" or "L" level for certain period while CLK is supplied, the panel displays black with some flicker.

Note 3) If CLK is fixed to "H" or "L" level for certain period while DE is supplied, the panel may be damaged.

Note 4) Please adjust LCD operating signal timing and FL driving frequency, to optimize the display quality.

There is a possibility that flicker is observed by the interference of LCD operating signal timing and FL driving condition (especially driving frequency), even if the condition satisfies above timing specifications .

Note5) Do not make t_v , t_h , t_{hbp} and t_{vds} fluctuate.

If t_v , t_h , t_{hbp} and t_{vds} are fluctuate, the panel displays black.

Note6) In case of using the long frame period, the deterioration of display quality, noise etc. may be occurred.

Note7) CLK count of each Horizontal Scanning Time should be always the same.

V-Blanking period should be " n " X "Horizontal Scanning Time". (n : integer)

Frame period should be always the same.

CONNECTOR PIN ASSIGNMENT FOR INTERFACE

CN1 INPUT SIGNAL

CN1 INPUT SIGNAL (FH23-25S-0.3SHW(05) : gilding terminal / HIROSE ELECTRIC CO., LTD.)

[Mating FPC : Use gilding terminal FPC]

Terminal No.	Symbol	Function
1	V _{DD}	Power Supply Voltage ; 3.3V
2	V _{DD}	Power Supply Voltage ; 3.3V
3	V _{DD}	Power Supply Voltage ; 3.3V
4	V _{DD}	Power Supply Voltage ; 3.3V
5	GND	GND
6	GND	GND
7	GND	GND
8	GND	GND
9	RxCLK+	Positive LVDS Differential clock input
10	GND	GND
11	RxCLK-	Negative LVDS Differential clock input
12	GND	GND
13	RxIN2+	Positive LVDS Differential data input , [B2-B5, V,H-sync, DE]
14	GND	GND
15	RxIN2-	Negative LVDS Differential data input , [B2-B5, V,H-sync, DE]
16	GND	GND
17	RxIN1+	Positive LVDS Differential data input , [G1-G5, B0-B1]
18	GND	GND
19	RxIN1-	Negative LVDS Differential data input , [G1-G5, B0-B1]
20	GND	GND
21	RxIN0+	Positive LVDS Differential data input , [R0-R5, G0]
22	GND	GND
23	RxIN0-	Negative LVDS Differential data input , [R0-R5, G0]
24	GND	GND
25	GND	GND

Note 1) Please connect GND pin to ground. Don't use it as no-connect nor connection with high impedance.

CN2 CCFL POWER SOURCE

Connector : BHSR-02VS-1 / JAPAN SOLDERLESS TERMINAL MFG CO., LTD.

Mating Connector : SM02B-BHS-1 / JAPAN SOLDERLESS TERMINAL MFG CO., LTD.

Terminal No.	Symbol	Function
1	V _{FLH}	CCFL Power Supply (high voltage)
2	V _{FLL}	CCFL Power Supply (low voltage)

**RECOMMENDED TRANSMITTER (DS90C363)
TO LTD056ET1S INTERFACE ASSIGNMENT**

Case1: 6bit Transmitter

Input Terminal No.		Input Signal (Graphics controller output signal)		Output Signal Symbol	To LTD056ET1S Interface(CN1)	
Symbol		Symbol	Function		Terminal	Symbol
TIN0	44	R0	Red Pixels Display Data (LSB)	TOUT0+ TOUT0-	No.21 No.23	IN0+ IN0-
TIN1	45	R1	Red Pixels Display Data			
TIN2	47	R2	Red Pixels Display Data			
TIN3	48	R3	Red Pixels Display Data			
TIN4	1	R4	Red Pixels Display Data			
TIN5	3	R5	Red Pixels Display Data (MSB)			
TIN6	4	G0	Green Pixels Display Data (LSB)	TOUT1+ TOUT1-	No.17 No.19	IN1+ IN1-
TIN7	6	G1	Green Pixels Display Data			
TIN8	7	G2	Green Pixels Display Data			
TIN9	9	G3	Green Pixels Display Data			
TIN10	10	G4	Green Pixels Display Data			
TIN11	12	G5	Green Pixels Display Data (MSB)			
TIN12	13	B0	Blue Pixels Display Data (LSB)	TOUT2+ TOUT2-	No.13 No.15	IN2+ IN2-
TIN13	15	B1	Blue Pixels Display Data			
TIN14	16	B2	Blue Pixels Display Data			
TIN15	18	B3	Blue Pixels Display Data			
TIN16	19	B4	Blue Pixels Display Data			
TIN17	20	B5	Blue Pixels Display Data (MSB)			
TIN18	22	HSYNC	H-Sync	TCLK OUT+ TCLK OUT-	No.9 No.11	CLK IN+ CLK IN-
TIN19	23	VSYNC	V-Sync			
TIN20	25	DE	Compound Synchronization Signal			
CLK IN	26	NCLK	Data Sampling Clock			

Note 1) Please connect NC pin to nothing. Don't connect it to ground nor to other signal input.

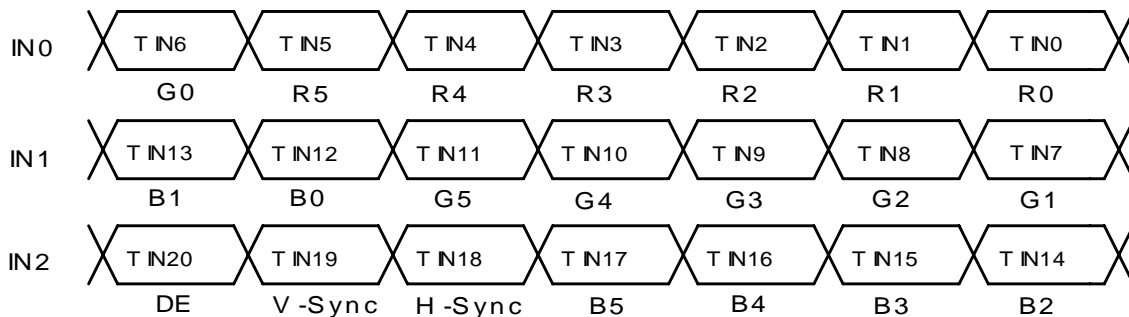

256k (k=1024) COLORS COMBINATION TABLE

	Display	R5 R4 R3 R2 R1 R0	G5 G4 G3 G2 G1 G0	B5 B4 B3 B2 B1 B0	Gray Scale Level
Basic Color	Black	L L L L L L L	L L L L L L L	L L L L L L L	-
	Blue	L L L L L L L	L L L L L L L	H H H H H H H	-
	Green	L L L L L L L	H H H H H H H	L L L L L L L	-
	Light Blue	L L L L L L L	H H H H H H H	H H H H H H H	-
	Red	H H H H H H H	L L L L L L L	L L L L L L L	-
	Purple	H H H H H H H	L L L L L L L	H H H H H H H	-
	Yellow	H H H H H H H	H H H H H H H	L L L L L L L	-
	White	H H H H H H H	H H H H H H H	H H H H H H H	-
Gray Scale of Red	Black	L L L L L L L	L L L L L L L	L L L L L L L	L 0
	Dark ↑ ↓ Light	L L L L L L H	L L L L L L L	L L L L L L L	L 1
		L L L L L H L	L L L L L L L	L L L L L L L	L 2
		: :	: :	: :	L3...
		: :	: :	: :	L60
		H H H H L H	L L L L L L L	L L L L L L L	L61
	H H H H H L	L L L L L L L	L L L L L L L	L62	
	Red	H H H H H H H	L L L L L L L	L L L L L L L	Red L63
Gray Scale of Green	Black	L L L L L L L	L L L L L L L	L L L L L L L	L 0
	Dark ↑ ↓ Light	L L L L L L L	L L L L L L H	L L L L L L L	L 1
		L L L L L L L	L L L L H L	L L L L L L L	L 2
		: :	: :	: :	L3...
		: :	: :	: :	L60
		L L L L L L L	H H H H L H	L L L L L L L	L61
	L L L L L L L	H H H H H L	L L L L L L L	L62	
	Green	L L L L L L L	H H H H H H H	L L L L L L L	Green L63
Gray Scale of Blue	Black	L L L L L L L	L L L L L L L	L L L L L L L	L 0
	Dark ↑ ↓ Light	L L L L L L L	L L L L L L L	L L L L L L H	L 1
		L L L L L L L	L L L L L L L	L L L L H L	L 2
		: :	: :	: :	L3...
		: :	: :	: :	L60
		L L L L L L L	L L L L L L L	H H H H L H	L61
	L L L L L L L	L L L L L L L	H H H H H L	L62	
	Blue	L L L L L L L	L L L L L L L	H H H H H H H	Blue L63
Gray Scale of White & Black	Black	L L L L L L L	L L L L L L L	L L L L L L L	L 0
	Dark ↑ ↓ Light	L L L L L L H	L L L L L L H	L L L L L L H	L 1
		L L L L L H L	L L L L L H L	L L L L L H L	L 2
		: :	: :	: :	L3...
		: :	: :	: :	L60
		H H H H L H	H H H H L H	H H H H L H	L61
	H H H H H L	H H H H H L	H H H H H L	L62	
	White	H H H H H H H	H H H H H H H	H H H H H H H	White L63



LCD module is generally designed with precise parts to achieve light weighted thin mechanical dimensions. In using our Modules, make certain that you fully understand and put into practice the warnings and safety precautions detailed in Engineering Information No.EE-D-001A,"CAUTIONS AND INSTRUCTIONS FOR TOSHIBA LCD MODULES". Refer to individual specifications and TECHNICAL DATA sheets (hereinafter called "TD") for more detailed technical information.

1) SPECIAL PURPOSES

A) Toshiba Matsushita Display Technology's Standard LCD Modules have not been customized for operation in extreme environments or for use in applications where performance failures could be life-threatening or otherwise catastrophic.

B) Since Toshiba Matsushita Display Technology's Standard LCD Modules have not been designed for operation in extreme environments, they must never be used in devices that will be exposed to abnormally high levels of vibration or shock which exceed Toshiba's published specification limits.

C) In addition, since Toshiba Matsushita Display Technology's Standard LCD Modules have not been designed for use in applications where performance failures could be life-threatening or catastrophic, they must never be installed in aircraft navigation control systems (such as, but not limited to Traffic Collision Avoidance System and Air Traffic Indicator), in military defense or weapons systems, in critical industrial process-control systems (e.g., those involved in the production of nuclear energy), or in critical medical device or patient life-support systems.

2) DISASSEMBLING OR MODIFICATION

DO NOT DISASSEMBLE OR MODIFY the module. It may damage sensitive parts inside LCD module, and may cause scratches or dust on the display.

Toshiba Matsushita Display Technology does not warrant the module, if customer disassembled or modified it.

3) BREAKAGE OF LCD PANEL

DO NOT INGEST liquid crystal material, DO NOT INHALE this material, and DO NOT CONTACT the material with skin, if LCD panel is broken and liquid crystal material spills out.

If liquid crystal material comes into mouth or eyes, rinse mouth or eyes out with water immediately.

If this material contact with skin or cloths, wash it off immediately with alcohol and rinse thoroughly with water.

4) GLASS OF LCD PANEL

BE CAREFUL WITH CHIPS OF GLASS that may cause injuring fingers or skin, when the glass is broken.

5) ELECTRIC SHOCK

DISCONNECT POWER SUPPLY before handling LCD module.

DO NOT TOUCH the parts inside LCD module and the fluorescent lamp's connector or cables in order to prevent electric shock, because high voltage is supplied to these parts from the inverter unit while power supply is turned on.

6) ABSOLUTE MAXIMUM RATINGS AND POWER PROTECTION CIRCUIT

DO NOT EXCEED the absolute maximum rating values under the worst probable conditions caused by the supply voltage variation, input voltage variation, variation in parts' constants, environmental temperature, etc., otherwise LCD module may be damaged.

Employ protection circuit for power supply, whenever the specification or TD specifies it.

Suitable protection circuit should be applied for each system design.

7) RECOMMENDED OPERATION CONDITIONS

The performance and quality of the LCD panel are warranted only when the LCD panel is used within "the recommended operation conditions". Toshiba Matsushita Display Technology Co., Ltd. never warrants the performance and quality of the LCD panel when you use the LCD panel over "the recommended operation conditions", although within "the absolute maximum rating".

To use the LCD panel over "the recommended operation conditions" may have bad influence on the characteristics and reliability of the LCD panel and may shorten the life of the LCD panel.

Therefore, when designing the whole set, not to be over "the recommended operation conditions", you should fully take care of supply voltage change, characteristic of connection parts, surge of input-and-output line, and surrounding temperature.

8) DISPOSAL

When dispose LCD module, obey to the applicable environmental regulations.